

Model EC45 IH - Deluxe Internal Halyard

Single sheave truck, cast aluminum revolving, internal halyard truck

1/8" x 7 x 19 Mil-C-5424
Stainless steel aircraft cable

Standard flag arrangement: 8' x 12'

Neoprene coated 2" diameter
steel counterweight

Nylon beaded retainer ring

Gearless, self locking direct drive
winch with six tumbler cylinder lock

Spun aluminum flash collar

3000 PSI concrete
(supplied by others)

Hardwood wedges
(supplied by others)

Dry sand tightly tamped
(supplied by others)

Foundation sleeve -
16 ga galvanized steel

Steel centering wedges

3/16" Steel base plate

3/16" Steel support plate
welded to grounding spike

3/4" Lightning ground spike

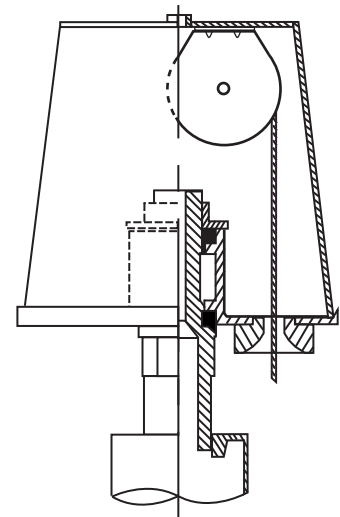
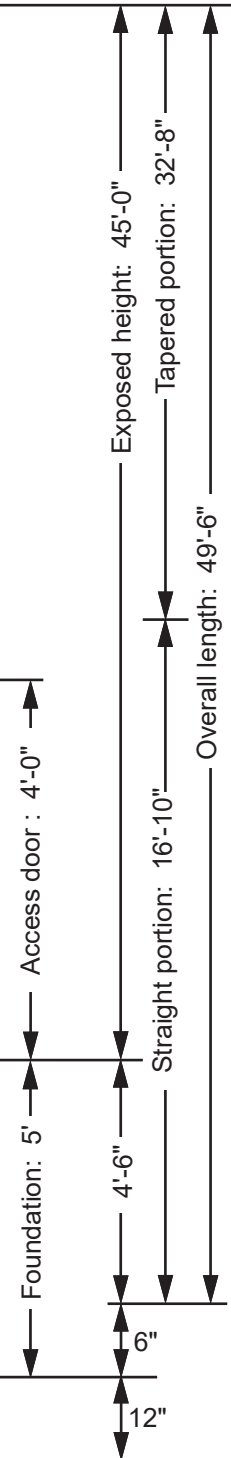

Revolving internal halyard truck, cast aluminum body, enclosed stainless steel ball bearings, raceway and 2-1/2" diameter plated steel sheave.

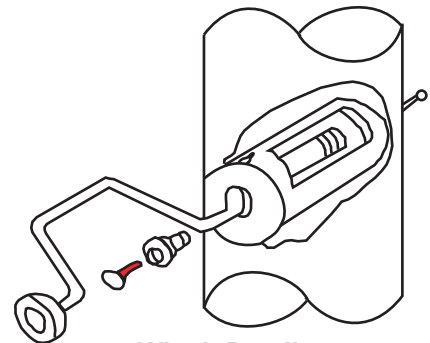

Winch Detail

All shafts with overall length of more than 38'-6" are shipped in two sections.

Each section matched and marked for field assembly. Exposed portion of jam sleeve must be **well lubricated** prior to assembly.

1-1/2" maximum shop gap allowed for field fitting (ram for tight joint)

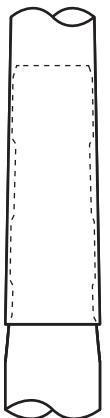

THE FLAG LOFT
1900 DELMAR BLVD
ST LOUIS MO 63103
800.99.3524

100 mph
FLAGGED

Exposed Height ___ 45'-0"
Overall Height ___ 49'-6"
Butt Diameter ___ 8"
Top Diameter ___ 3-1/2"
Wall Thickness ___ .188"
Ships in 2 sections

Ground set tapered
aluminum flagpole
ALLOY 6063T6
80 grit polish

**EDER POLE
MANUFACTURER**